



TS914

# RAIL TO RAIL CMOS QUAD OPERATIONAL AMPLIFIER

- RAIL TO RAIL INPUT AND OUTPUT VOLTAGE RANGES
- SINGLE (OR DUAL) SUPPLY OPERATION FROM 2.7V TO 16V
- EXTREMELY LOW INPUT BIAS CURRENT : 1pA typ
- LOW INPUT OFFSET VOLTAGE : 2mV max.
- SPECIFIED FOR 600Ω AND 100Ω LOADS
- LOW SUPPLY CURRENT : 200μA/Ampli ( $V_{CC} = 3V$ )
- LATCH-UP IMMUNITY
  
- SPICE MACROMODEL INCLUDED IN THIS-SPECIFICATION

### DESCRIPTION

The TS914 is a RAIL TO RAIL CMOS quad operational amplifier designed to operate with a single or dual supply voltage.

The input voltage range  $V_{icm}$  includes the two supply rails  $V_{CC}^+$  and  $V_{CC}^-$ .

The output reaches :

- $V_{CC}^- +50mV$   $V_{CC}^+ -50mV$  with  $R_L = 10k\Omega$
- $V_{CC}^- +350mV$   $V_{CC}^+ -350mV$  with  $R_L = 600\Omega$

This product offers a broad supply voltage operating range from 2.7V to 16V and a supply current of only 200μA/amp. ( $V_{CC} = 3V$ ).

Source and sink output current capability is typically 40mA (at  $V_{CC} = 3V$ ), fixed by an internal limitation circuit.

### ORDER CODE

Part Number	Temperature Range	Package	
		N	D
TS914I/AI	-40, +125°C	•	•

N = Dual in Line Package (DIP)  
D = Small Outline Package (SO) - also available in Tape & Reel (DT)

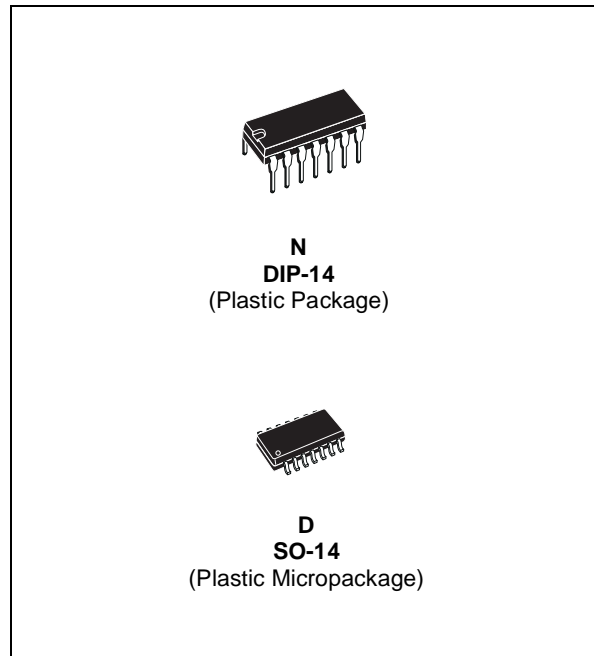

### PIN CONNECTIONS (top view)

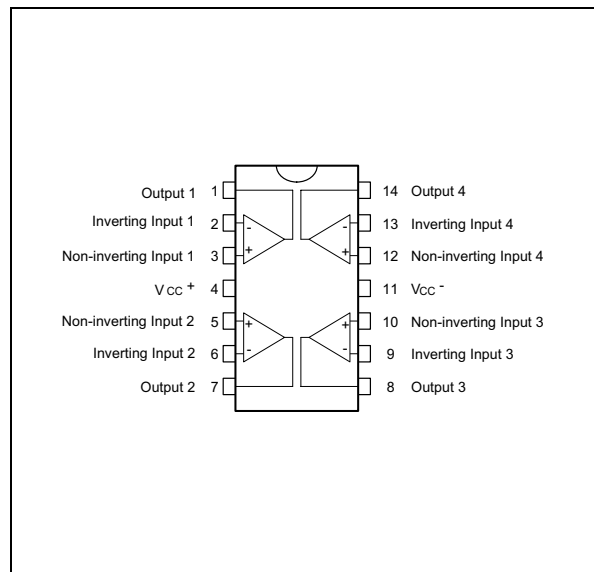

**SCHEMATIC DIAGRAM (1/2 TS914)**

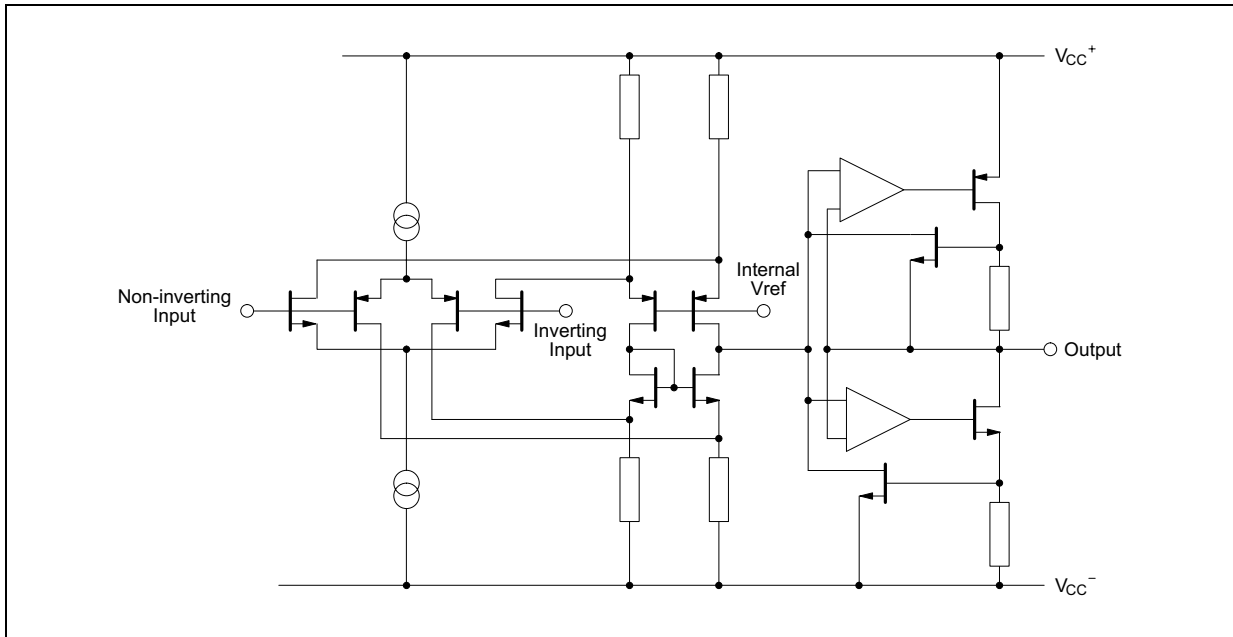

**ABSOLUTE MAXIMUM RATINGS**

Symbol	Parameter	Value	Unit
$V_{CC}$	Supply voltage <sup>1)</sup>	18	V
$V_{id}$	Differential Input Voltage <sup>2)</sup>	$\pm 18$	V
$V_i$	Input Voltage <sup>3)</sup>	-0.3 to 18	V
$I_{in}$	Current on Inputs	$\pm 50$	mA
$I_o$	Current on Outputs	$\pm 130$	mA
$T_{oper}$	Operating Free Air Temperature Range TS914/AI	-40 to + 125	$^{\circ}C$
$T_{stg}$	Storage Temperature	-65 to +150	$^{\circ}C$

1. All voltages values, except differential voltage are with respect to network ground terminal.
2. Differential voltages are non-inverting input terminal with respect to the inverting input terminal.
3. The magnitude of input and output voltages must never exceed  $V_{CC}^{+} + 0.3V$ .

**OPERATING CONDITIONS**

Symbol	Parameter	Value	Unit
$V_{CC}$	Supply voltage	2.7 to 16	V
$V_{icm}$	Common Mode Input Voltage Range	$V_{CC}^{-} - 0.2$ to $V_{CC}^{+} + 0.2$	V

**ELECTRICAL CHARACTERISTICS**

$V_{CC^+} = 3V$ ,  $V_{CC^-} = 0V$ ,  $R_L$ ,  $C_L$  connected to  $V_{CC/2}$ ,  $T_{amb} = 25^\circ C$  (unless otherwise specified)

Symbol	Parameter	Min.	Typ.	Max.	Unit
$V_{io}$	Input Offset Voltage ( $V_{ic} = V_o = V_{CC/2}$ ) $T_{min.} \leq T_{amb} \leq T_{max.}$			10 5 12 7	mV
$\Delta V_{io}$	Input Offset Voltage Drift		5		$\mu V/^\circ C$
$I_{io}$	Input Offset Current <sup>1)</sup> $T_{min.} \leq T_{amb} \leq T_{max.}$		1	100 200	pA
$I_{ib}$	Input Bias Current <sup>1)</sup> $T_{min.} \leq T_{amb} \leq T_{max.}$		1	150 300	pA
$I_{CC}$	Supply Current (per amplifier, $A_{VCL} = 1$ , no load) $T_{min.} \leq T_{amb} \leq T_{max.}$		200	300 400	$\mu A$
CMR	Common Mode Rejection Ratio $V_{ic} = 0$ to $3V$ , $V_o = 1.5V$		70		dB
SVR	Supply Voltage Rejection Ratio ( $V_{CC^+} = 2.7$ to $3.3V$ , $V_o = V_{CC/2}$ )		80		dB
$A_{vd}$	Large Signal Voltage Gain ( $R_L = 10k\Omega$ , $V_o = 1.2V$ to $1.8V$ ) $T_{min.} \leq T_{amb} \leq T_{max.}$	3 2	10		V/mV
$V_{OH}$	High Level Output Voltage ( $V_{id} = 1V$ ) $T_{min.} \leq T_{amb} \leq T_{max.}$	$R_L = 10k\Omega$ 2.9 $R_L = 600\Omega$ 2.2 $R_L = 100\Omega$ 2.8 $R_L = 10k\Omega$ 2.1 $R_L = 600\Omega$	2.97 2.7 2		V
$V_{OL}$	Low Level Output Voltage ( $V_{id} = -1V$ ) $T_{min.} \leq T_{amb} \leq T_{max.}$	$R_L = 10k\Omega$ $R_L = 600\Omega$ $R_L = 100\Omega$ $R_L = 10k\Omega$ $R_L = 600\Omega$	50 300 900	100 600 150 900	mV
$I_o$	Output Short Circuit Current ( $V_{id} = \pm 1V$ )	Source ( $V_o = V_{CC}$ ) Sink ( $V_o = V_{CC^+}$ )	40 40		mA
GBP	Gain Bandwidth Product ( $A_{VCL} = 100$ , $R_L = 10k\Omega$ , $C_L = 100pF$ , $f = 100kHz$ )		0.8		MHz
SR	Slew Rate ( $A_{VCL} = 1$ , $R_L = 10k\Omega$ , $C_L = 100pF$ , $V_i = 1.3V$ to $1.7V$ )		0.5		V/ $\mu s$
$\phi_m$	Phase Margin		30		Degrees
en	Equivalent Input Noise Voltage ( $R_s = 100\Omega$ , $f = 1kHz$ )		30		nV/ $\sqrt{Hz}$
$V_{O1}/V_{O2}$	Channel Separation ( $f = 1kHz$ )		120		dB

1. Maximum values including unavoidable inaccuracies of the industrial test

**ELECTRICAL CHARACTERISTICS**

$V_{CC^+} = 5V$ ,  $V_{CC^-} = 0V$ ,  $R_L$ ,  $C_L$  connected to  $V_{CC/2}$ ,  $T_{amb} = 25^\circ C$  (unless otherwise specified)

Symbol	Parameter	Min.	Typ.	Max.	Unit
$V_{io}$	Input Offset Voltage ( $V_{ic} = V_o = V_{CC/2}$ ) $T_{min.} \leq T_{amb} \leq T_{max.}$			10 5 12 7	mV
$\Delta V_{io}$	Input Offset Voltage Drift		5		$\mu V/^\circ C$
$I_{io}$	Input Offset Current <sup>1)</sup> $T_{min.} \leq T_{amb} \leq T_{max.}$		1	100 200	pA
$I_{ib}$	Input Bias Current <sup>1)</sup> $T_{min.} \leq T_{amb} \leq T_{max.}$		1	150 300	pA
$I_{CC}$	Supply Current (per amplifier, $A_{VCL} = 1$ , no load) $T_{min.} \leq T_{amb} \leq T_{max.}$		230	350 450	$\mu A$
CMR	Common Mode Rejection Ratio $V_{ic} = 1.5$ to $3.5V$ , $V_o = 2.5V$		85		dB
SVR	Supply Voltage Rejection Ratio ( $V_{CC^+} = 3$ to $5V$ , $V_o = V_{CC/2}$ )		80		dB
$A_{vd}$	Large Signal Voltage Gain ( $R_L = 10k\Omega$ , $V_o = 1.5V$ to $3.5V$ ) $T_{min.} \leq T_{amb} \leq T_{max.}$	10 7	40		V/mV
$V_{OH}$	High Level Output Voltage ( $V_{id} = 1V$ ) $T_{min.} \leq T_{amb} \leq T_{max.}$	$R_L = 10k\Omega$ 4.85 $R_L = 600\Omega$ 4.20 $R_L = 100\Omega$ 4.8 $R_L = 10k\Omega$ 4.1 $R_L = 600\Omega$	4.95 4.65 3.7		V
$V_{OL}$	Low Level Output Voltage ( $V_{id} = -1V$ ) $T_{min.} \leq T_{amb} \leq T_{max.}$	$R_L = 10k\Omega$ $R_L = 600\Omega$ $R_L = 100\Omega$ $R_L = 10k\Omega$ $R_L = 600\Omega$	50 350 1400	100 680 150 900	mV
$I_o$	Output Short Circuit Current ( $V_{id} = \pm 1V$ )	Source ( $V_o = V_{CC}$ ) Sink ( $V_o = V_{CC^+}$ )	60 60		mA
GBP	Gain Bandwidth Product ( $A_{VCL} = 100$ , $R_L = 10k\Omega$ , $C_L = 100pF$ , $f = 100kHz$ )		1		MHz
SR	Slew Rate ( $A_{VCL} = 1$ , $R_L = 10k\Omega$ , $C_L = 100pF$ , $V_i = 1V$ to $4V$ )		0.8		V/ $\mu s$
$\phi_m$	Phase Margin		30		Degrees
$e_n$	Equivalent Input Noise Voltage ( $R_s = 100\Omega$ , $f = 1kHz$ )		30		nV/ $\sqrt{Hz}$
$V_{O1}/V_{O2}$	Channel Separation ( $f = 1kHz$ )		120		dB

1. Maximum values including unavoidable inaccuracies of the industrial test

**ELECTRICAL CHARACTERISTICS**

$V_{CC^+} = 10V$ ,  $V_{DD} = 0V$ ,  $R_L$ ,  $C_L$  connected to  $V_{CC/2}$ ,  $T_{amb} = 25^\circ C$  (unless otherwise specified)

Symbol	Parameter	Min.	Typ.	Max.	Unit	
$V_{io}$	Input Offset Voltage ( $V_{ic} = V_o = V_{CC/2}$ )			10	mV	
	$T_{min.} \leq T_{amb} \leq T_{max.}$			5		
				12		
				7		
$\Delta V_{io}$	Input Offset Voltage Drift		5		$\mu V/^\circ C$	
$I_{io}$	Input Offset Current <sup>1)</sup>		1	100	pA	
	$T_{min.} \leq T_{amb} \leq T_{max.}$			200		
$I_{ib}$	Input Bias Current <sup>1)</sup>		1	150	pA	
	$T_{min.} \leq T_{amb} \leq T_{max.}$			300		
$V_{icm}$	Common Mode Input Voltage Range	$V_{DD} - 0.2$ to $V_{CC^+} + 0.2$			V	
CMR	Common Mode Rejection Ratio		90		dB	
	$V_{ic} = 3$ to $7V$ , $V_o = 5V$		75			
	$V_{ic} = 0$ to $10V$ , $V_o = 5V$					
SVR	Supply Voltage Rejection Ratio ( $V_{CC^+} = 5$ to $10V$ , $V_o = V_{CC/2}$ )		90		dB	
$A_{vd}$	Large Signal Voltage Gain ( $R_L = 10k\Omega$ , $V_o = 2.5V$ to $7.5V$ )	15	60		V/mV	
	$T_{min.} \leq T_{amb} \leq T_{max.}$	10				
$V_{OH}$	High Level Output Voltage ( $V_{id} = 1V$ )	$R_L = 10k\Omega$	9.85	9.95	V	
		$R_L = 600\Omega$	9	9.35		
		$R_L = 100\Omega$		7.8		
		$R_L = 10k\Omega$	9.8			
	$T_{min.} \leq T_{amb} \leq T_{max.}$		9			
$V_{OL}$	Low Level Output Voltage ( $V_{id} = -1V$ )	$R_L = 10k\Omega$		50	180	mV
		$R_L = 600\Omega$		650	800	
		$R_L = 100\Omega$		2300		
		$R_L = 10k\Omega$			150	
	$T_{min.} \leq T_{amb} \leq T_{max.}$				900	
$I_o$	Output Short Circuit Current ( $V_{id} = \pm 1V$ )		60		mA	
$I_{CC}$	Supply Current (per amplifier, $A_{VCL} = 1$ , no load)		400	600	$\mu A$	
	$T_{min.} \leq T_{amb} \leq T_{max.}$			700		
GBP	Gain Bandwidth Product ( $A_{VCL} = 100$ , $R_L = 10k\Omega$ , $C_L = 100pF$ , $f = 100kHz$ )		1.4		MHz	
SR	Slew Rate ( $A_{VCL} = 1$ , $R_L = 10k\Omega$ , $C_L = 100pF$ , $V_i = 2.5V$ to $7.5V$ )		1		V/ $\mu s$	
$\phi_m$	Phase Margin		40		Degrees	
en	Equivalent Input Noise Voltage ( $R_s = 100\Omega$ , $f = 1kHz$ )		30		nV/ $\sqrt{Hz}$	
THD	Total Harmonic Distortion ( $A_{VCL} = 1$ , $R_L = 10k\Omega$ , $C_L = 100pF$ , $V_o = 4.75V$ to $5.25V$ , $f = 1kHz$ )		0.02		%	
$C_{in}$	Input Capacitance		1.5		pF	
$R_{in}$	Input Resistance		>10		Tera $\Omega$	
$V_{O1}/V_{O2}$	Channel Separation ( $f = 1kHz$ )		120		dB	

1. Maximum values including unavoidable inaccuracies of the industrial test

TYPICAL CHARACTERISTICS

Figure 1 : Supply Current (each amplifier) vs Supply Voltage

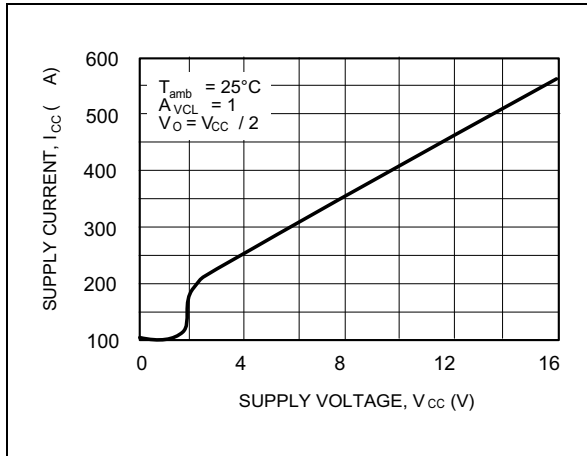

Figure 2 : Input Bias Current vs Temperature

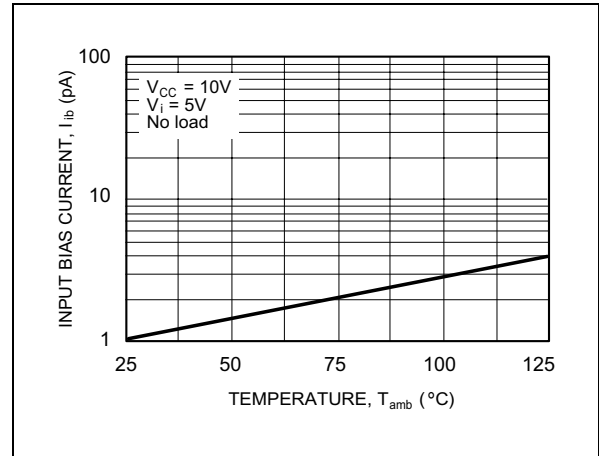

Figure 3a : High Level Output Voltage vs High Level Output Current

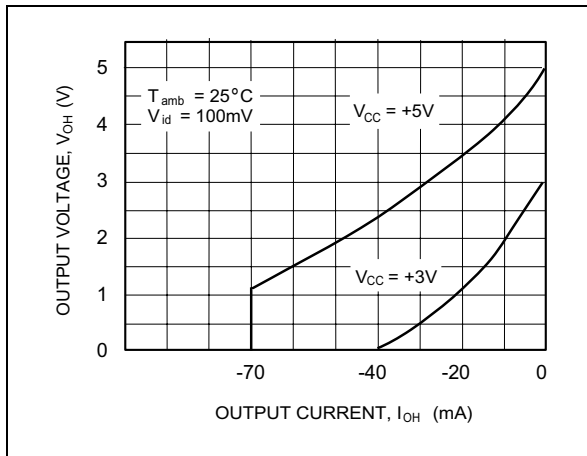

Figure 3b : High Level Output Voltage vs High Level Output Current

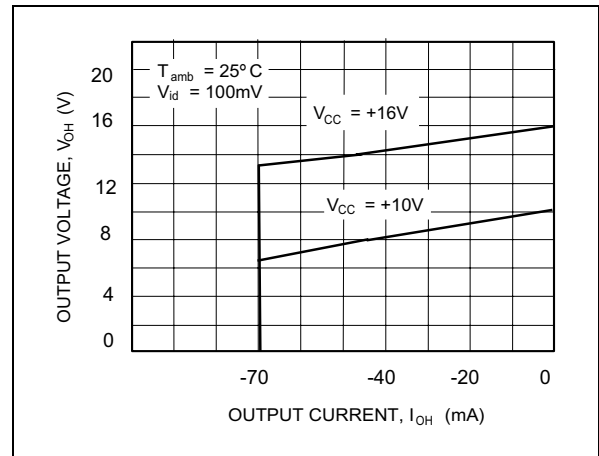

Figure 4a : Low Level Output Voltage vs Low Level Output Current

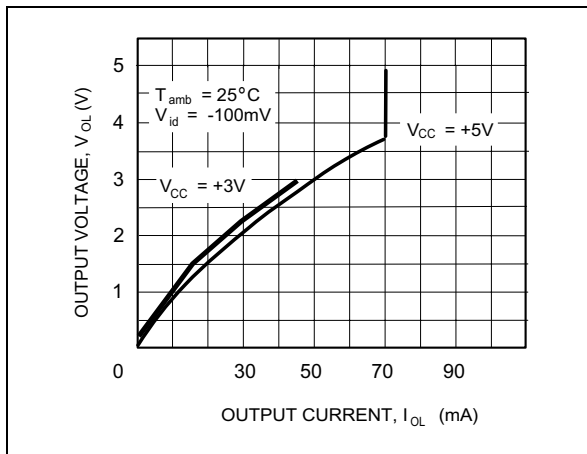

Figure 4b : Low Level Output Voltage vs Low Level Output Current

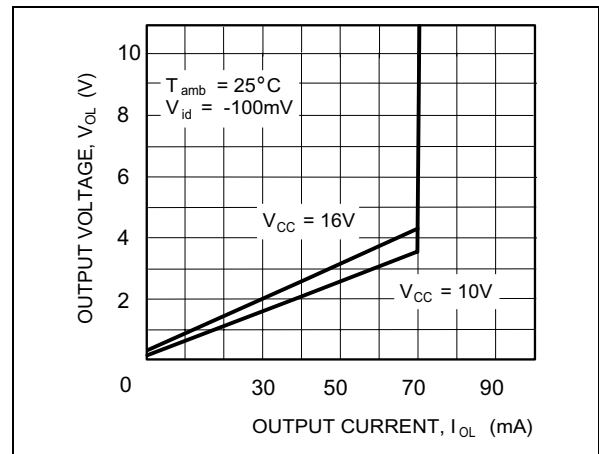

Figure 5a : Gain and Phase vs Frequency

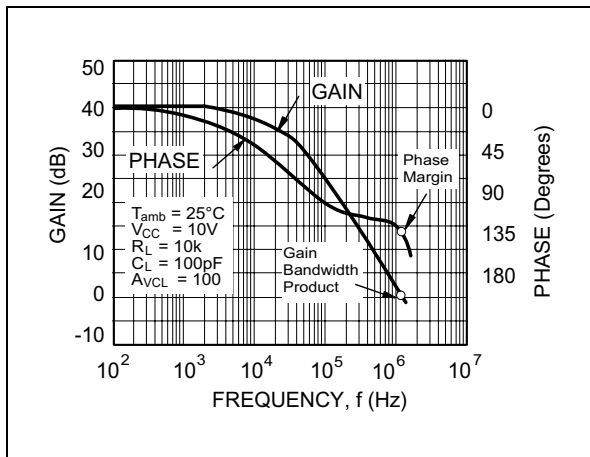

Figure 5b : Gain and Phase vs Frequency

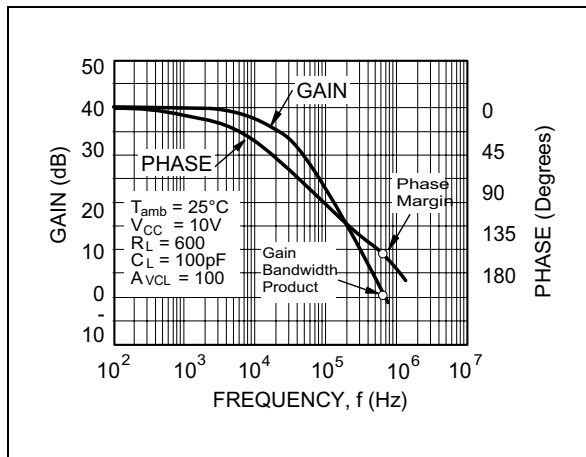

Figure 6a : Gain Bandwidth Product vs Supply Voltage

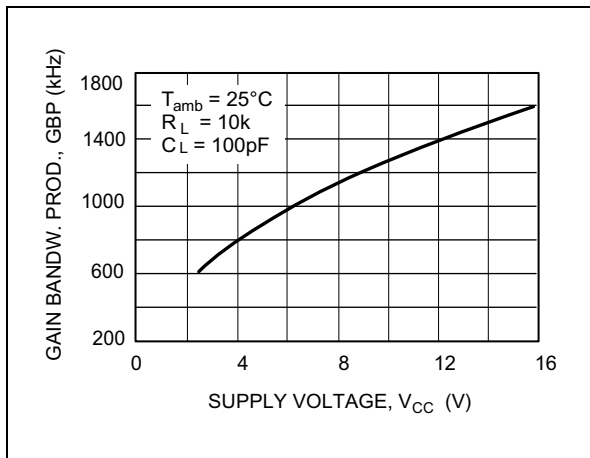

Figure 6b : Gain Bandwidth Product vs Supply Voltage

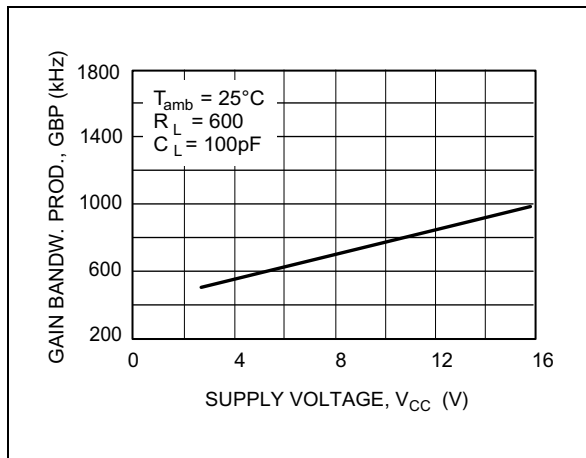

Figure 7a : Phase Margin vs Supply Voltage

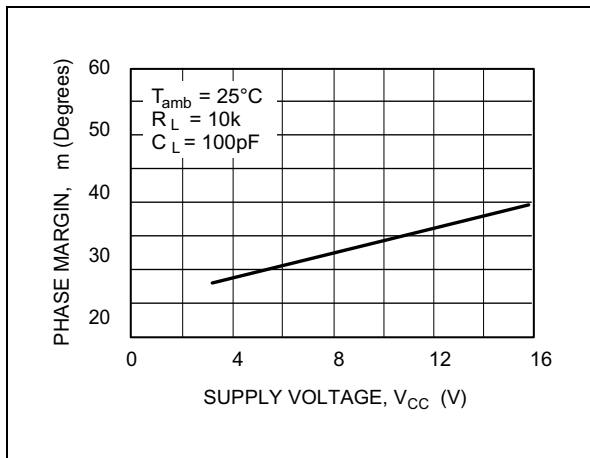

Figure 7b : Phase Margin vs Supply Voltage

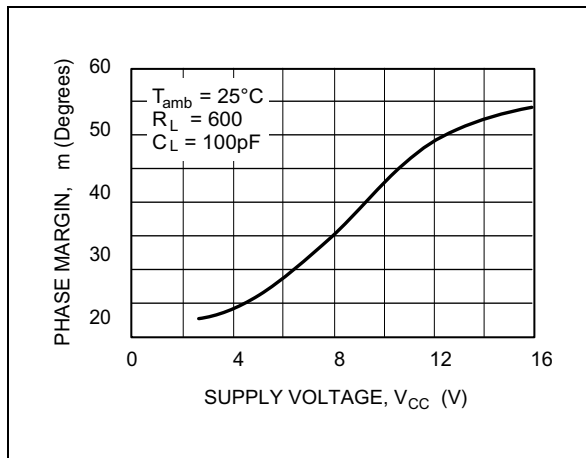
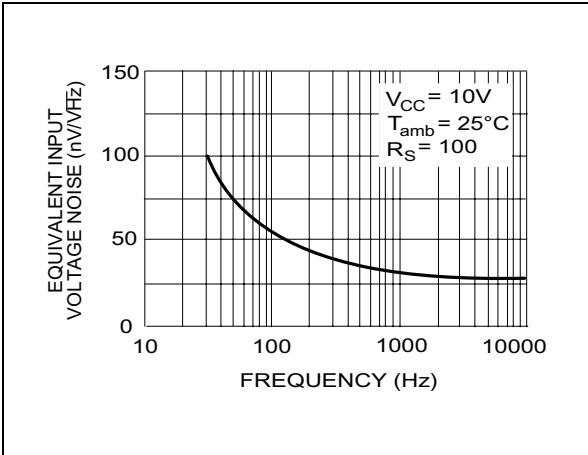

Figure 8 : Input Voltage Noise vs Frequency





**MACROMODEL**

**Applies to : TS914i,AI,BI (V<sub>CC</sub> = 3V)**

\*\* Standard Linear Ics Macromodels, 1993.

\*\* CONNECTIONS :

\* 1 INVERTING INPUT

\* 2 NON-INVERTING INPUT

\* 3 OUTPUT

\* 4 POSITIVE POWER SUPPLY

\* 5 NEGATIVE POWER SUPPLY

.SUBCKT TS914\_3 1 3 2 4 5 (analog)

\*\*\*\*\*

.MODEL MDTH D IS=1E-8 KF=6.564344E-14 CJO=10F

\* INPUT STAGE

CIP 2 5 1.000000E-12

CIN 1 5 1.000000E-12

EIP 10 5 2 5 1

EIN 16 5 1 5 1

RIP 10 11 6.500000E+00

RIN 15 16 6.500000E+00

RIS 11 15 1.271505E+01

DIP 11 12 MDTH 400E-12

DIN 15 14 MDTH 400E-12

VOFP 12 13 DC 0.000000E+00

VOFN 13 14 DC 0

IPOL 13 5 4.000000E-05

CPS 11 15 2.125860E-08

DINN 17 13 MDTH 400E-12

VIN 17 5 0.000000E+00

DINR 15 18 MDTH 400E-12

VIP 4 18 0.000000E+00

FCP 4 5 VOFP 5.000000E+00

FCN 5 4 VOFN 5.000000E+00

\* AMPLIFYING STAGE

FIP 5 19 VOFP 2.750000E+02

FIN 5 19 VOFN 2.750000E+02

RG1 19 5 1.916825E+05

RG2 19 4 1.916825E+05

CC 19 29 2.200000E-08

HZTP 30 29 VOFP 1.3E+03

HZTN 5 30 VOFN 1.3E+03

DOPM 19 22 MDTH 400E-12

DONM 21 19 MDTH 400E-12

HOPM 22 28 VOUT 3800

VIPM 28 4 150

HONM 21 27 VOUT 3800

VINM 5 27 150

EOUT 26 23 19 5 1

VOUT 23 5 0

ROUT 26 3 75

COU 3 5 1.000000E-12

DOP 19 68 MDTH 400E-12

VOP 4 25 1.724

HSCP 68 25 VSCP1 0.8E8

DON 69 19 MDTH 400E-12

VON 24 5 1.7419107

HSCN 24 69 VSCN1 0.8E+08

VSCTHP 60 61 0.0875

\*\* VSCTHP = le seuil au dessus de vio

\* 500

\*\* c.a.d 275U-000U dus a l'offset

DSCP1 61 63 MDTH 400E-12

VSCP1 63 64 0

ISCP 64 0 1.000000E-8

DSCP2 0 64 MDTH 400E-12

DSCN2 0 74 MDTH 400E-12

ISCN 74 0 1.000000E-8

VSCN1 73 74 0

DSCN1 71 73 MDTH 400E-12

VSCTHN 71 70 -0.55

\*\* VSCTHN = le seuil au dessous de vio

\* 2000

\*\* c.a.d -375U-000U dus a l'offset

ESCP 60 0 2 1 500

ESCN 70 0 2 1 -2000

.ENDS

**ELECTRICAL CHARACTERISTICS**

V<sub>CC</sub><sup>+</sup> = 3V, V<sub>CC</sub><sup>-</sup> = 0V, R<sub>L</sub>, C<sub>L</sub> connected to V<sub>CC/2</sub>, T<sub>amb</sub> = 25°C (unless otherwise specified)

Symbol	Conditions	Value	Unit
V <sub>io</sub>		0	mV
A <sub>vd</sub>	R <sub>L</sub> = 10kΩ	10	V/mV
I <sub>CC</sub>	No load, per operator	100	μA
V <sub>Icm</sub>		-0.2 to 3.2	V
V <sub>OH</sub>	R <sub>L</sub> = 600Ω	2.96	V
V <sub>OL</sub>	R <sub>L</sub> = 60Ω	300	mV
I <sub>sink</sub>	V <sub>O</sub> = 3V	40	mA
I <sub>source</sub>	V <sub>O</sub> = 0V	40	mA
GBP	R <sub>L</sub> = 10kΩ, C <sub>L</sub> = 100pF	0.8	MHz
SR	R <sub>L</sub> = 10kΩ, C <sub>L</sub> = 100pF	0.3	V/μs
φ <sub>m</sub>	Phase Margin	30	Degrees



**MACROMODEL**

**Applies to : TS914I,AI,BI (V<sub>CC</sub> = 5V)**

\*\* Standard Linear lcs Macromodels, 1993.

\*\* CONNECTIONS :

\* 1 INVERTING INPUT

\* 2 NON-INVERTING INPUT

\* 3 OUTPUT

\* 4 POSITIVE POWER SUPPLY

\* 5 NEGATIVE POWER SUPPLY

\* 6 STANDBY

.SUBCKT TS914\_5 1 3 2 4 5 (analog)

\*\*\*\*\*

.MODEL MDTH D IS=1E-8 KF=6.564344E-14 CJO=10F

\* INPUT STAGE

CIP 2 5 1.000000E-12

CIN 1 5 1.000000E-12

EIP 10 5 2 5 1

EIN 16 5 1 5 1

RIP 10 11 6.500000E+00

RIN 15 16 6.500000E+00

RIS 11 15 7.322092E+00

DIP 11 12 MDTH 400E-12

DIN 15 14 MDTH 400E-12

VOFP 12 13 DC 0.000000E+00

VOFN 13 14 DC 0

IPOL 13 5 4.000000E-05

CPS 11 15 2.498970E-08

DINN 17 13 MDTH 400E-12

VIN 17 5 0.000000E+00

DINR 15 18 MDTH 400E-12

VIP 4 18 0.000000E+00

FCP 4 5 VOFP 5.750000E+00

FCN 5 4 VOFN 5.750000E+00

ISTB0 5 4 500N

\* AMPLIFYING STAGE

FIP 5 19 VOFP 4.400000E+02

FIN 5 19 VOFN 4.400000E+02

RG1 19 5 4.904961E+05

RG2 19 4 4.904961E+05

CC 19 29 2.200000E-08

HZTP 30 29 VOFP 1.8E+03

HZTN 5 30 VOFN 1.8E+03

DOPM 19 22 MDTH 400E-12

DONM 21 19 MDTH 400E-12

HOPM 22 28 VOUT 3800

VIPM 28 4 230

HONM 21 27 VOUT 3800

VINM 5 27 230

EOUT 26 23 19 5 1

VOUT 23 5 0

ROUT 26 3 82

COUT 3 5 1.000000E-12

DOP 19 68 MDTH 400E-12

VOP 4 25 1.724

HSCP 68 25

VSCP1 0.8E+08

DON 69 19 MDTH 400E-12

VON 24 5 1.7419107

HSCN 24 69

VSCN1 0.8E+08

VSCTHP 60 61 0.0875

\*\* VSCTHP = le seuil au dessus de vio

\* 500

\*\* c.a.d 275U-000U dus a l'offset

DSCP1 61 63 MDTH 400E-12

VSCP1 63 64 0

ISCP 64 0 1.000000E-8

DSCP2 0 64 MDTH 400E-12

DSCN2 0 74 MDTH 400E-12

ISCN 74 0 1.000000E-8

VSCN1 73 74 0

DSCN1 71 73 MDTH 400E-12

VSCTHN 71 70 -0.55

\*\* VSCTHN = le seuil au dessous de vio

\* 2000

\*\* c.a.d -375U-000U dus a l'offset

ESCP 60 0 2 1 500

ESCN 70 0 2 1 -2000

.ENDS

**PACKAGE MECHANICAL DATA**  
14 PINS - PLASTIC DIP

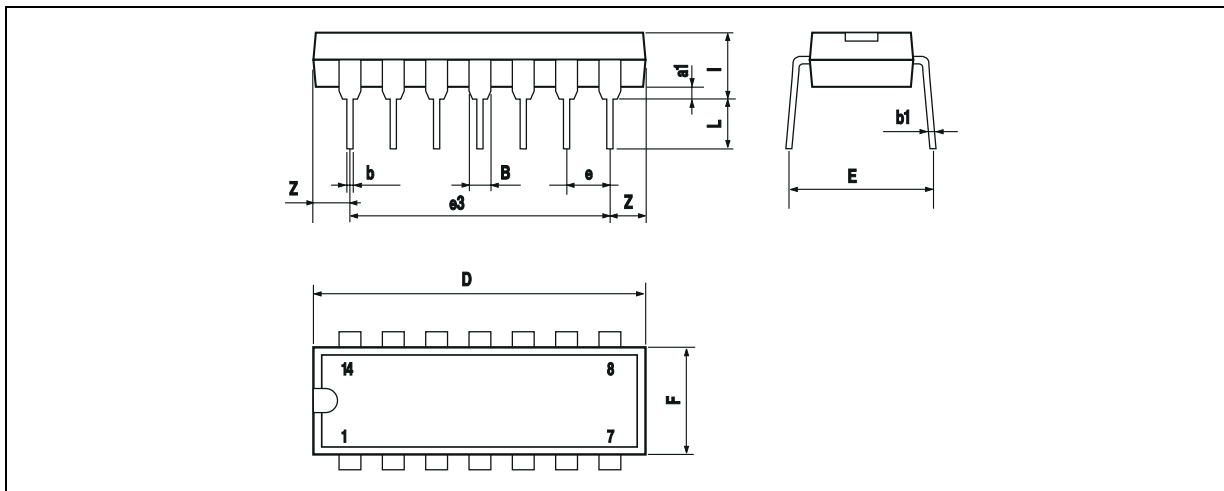

Dim.	Millimeters			Inches		
	Min.	Typ.	Max.	Min.	Typ.	Max.
a1	0.51			0.020		
B	1.39		1.65	0.055		0.065
b		0.5			0.020	
b1		0.25			0.010	
D			20			0.787
E		8.5			0.335	
e		2.54			0.100	
e3		15.24			0.600	
F			7.1			0.280
i			5.1			0.201
L		3.3			0.130	
Z	1.27		2.54	0.050		0.100

**PACKAGE MECHANICAL DATA**  
 14 PINS - PLASTIC MICROPACKAGE (SO)

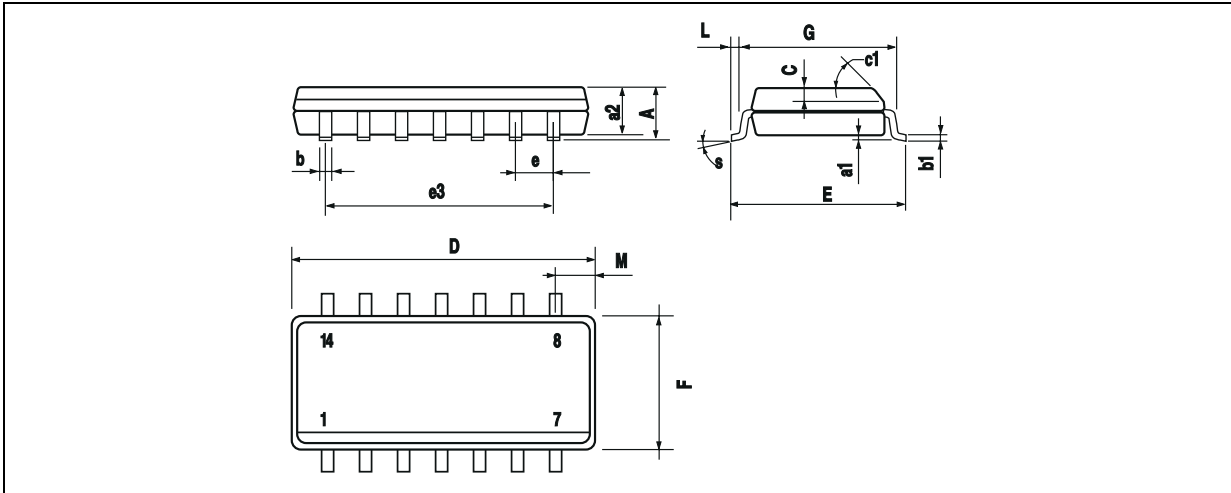

Dim.	Millimeters			Inches		
	Min.	Typ.	Max.	Min.	Typ.	Max.
A			1.75			0.069
a1	0.1		0.2	0.004		0.008
a2			1.6			0.063
b	0.35		0.46	0.014		0.018
b1	0.19		0.25	0.007		0.010
C		0.5			0.020	
c1	45° (typ.)					
D (1)	8.55		8.75	0.336		0.344
E	5.8		6.2	0.228		0.244
e		1.27			0.050	
e3		7.62			0.300	
F (1)	3.8		4.0	0.150		0.157
G	4.6		5.3	0.181		0.208
L	0.5		1.27	0.020		0.050
M			0.68			0.027
S	8° (max.)					

Note : (1) D and F do not include mold flash or protrusions - Mold flash or protrusions shall not exceed 0.15mm (.066 inc) ONLY FOR DATA BOOK.

Information furnished is believed to be accurate and reliable. However, STMicroelectronics assumes no responsibility for the consequences of use of such information nor for any infringement of patents or other rights of third parties which may result from its use. No license is granted by implication or otherwise under any patent or patent rights of STMicroelectronics. Specifications mentioned in this publication are subject to change without notice. This publication supersedes and replaces all information previously supplied. STMicroelectronics products are not authorized for use as critical components in life support devices or systems without express written approval of STMicroelectronics.

© The ST logo is a registered trademark of STMicroelectronics

© 2001 STMicroelectronics - Printed in Italy - All Rights Reserved  
 STMicroelectronics GROUP OF COMPANIES

Australia - Brazil - Canada - China - Finland - France - Germany - Hong Kong - India - Israel - Italy - Japan - Malaysia  
 Malta - Morocco - Singapore - Spain - Sweden - Switzerland - United Kingdom - United States

© <http://www.st.com>

This datasheet has been download from:

[www.datasheetcatalog.com](http://www.datasheetcatalog.com)

Datasheets for electronics components.